

Park 60W LED Bulkhead Datasheet

5000K 8400Lm LED Batten

PXPARK60

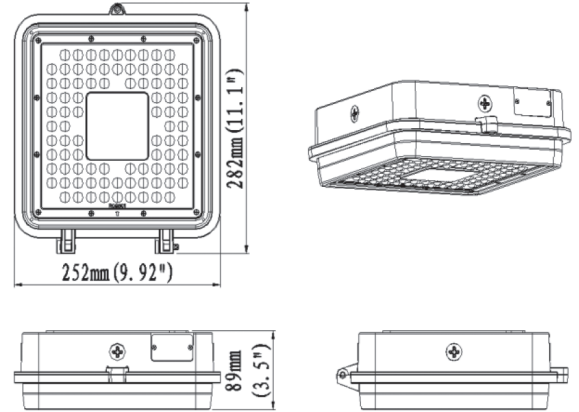

Power	60±3W
Luminous Flux	8400(±5%)LM
Efficacy	140(±5%)LM/W(5000K Ra70)
Colour Temperature	5000K
Colour Rendering Index	Ra70
Beam Angle	147° (R08801)
Power Supply	Sosen Driver
Input Voltage	100-240 VAC / 100-277 VAC
Power Factor	≥0.9
Frequency	50 / 60 Hz
Surge Protection	2kV line-line, 4kV line-earth
Driver Type	Constant Current (CC)
Product Dimension	282×252×89mm (11.1"×9.92"×3.5")
Luminaire Net Weight	2.5±0.3kg(5.51±0.66Lbs)
Material	Aluminium Body & PC Optical Lens
Finish	Powder Coating
Fixture Colour	Bronze
IP Rating	IP65

Mounting Options	Ceiling / NPS Pole
Operating Temp	-30°C to + 50°C
Lifetime	50,000Hrs (Ta=30°C@L70)
Dimmable	No
Warranty	5 Years
Product Code	PXPARK60

Features & Applications

Robust, powerful and highly efficient, the new IP65 Park fitting is the next generation of LED lighting for underground and multi-storey car parks. Park produces an exceptional 140Lm/W and provides optimal low glare illumination with a wide 147° beam angle for dark and damp spaces.