

Nico Dim White 35W Datasheet

4000K 3180Lm LED Track Spotlight

PX35WH4KD

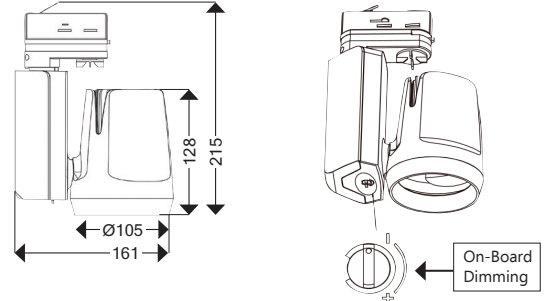

Beam Angle

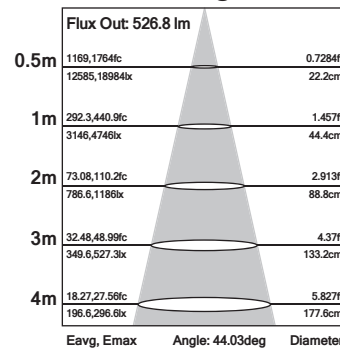

Input Rated Voltage	AC230V
Frequency	50Hz
Input Voltage	AC200-240V
Efficiency	≥87%
Total Load Wattage	35W±5W
Power Factor	≥0.9
Lumen Output ±5%	3180lm
Beam Angle	36°
CCT	4000K
Lifespan	40000h
CRI	≥80
Dimensions	L161*W105*H215mm
Rated Input Current	≤0.2A
Full Load Output Voltage	DC25-38V
Rated Output Current	820mA
Output Current Range	820mA±5%
Power Tolerance	±5%
Current Output Tolerance	±5%
Dimming Range	8-100%
Dimmer	On-Board Dimming
Short Circuit Protection	PASS
Over Voltage Protection	PASS
Over Temperature Protection	PASS
THD	≤18%
Withstand Voltage	AC1500V

Features & Applications

Nico Dim adopts CREE LEDs with excellent color rendering index to increase the color fidelity of the target illuminated object and provide an even light output without glare or dark spots. Nico Dim adjusts 360° degrees horizontally and 180° vertically.

- Environment friendly, without Mercury or other hazardous substances
- Up to 70% energy saving compared to standard CFL
- Adjustable 360° degrees horizontally, 180° degrees vertically
- Long lifetime of 40,000 hours
- 36° beam angle
- On-board Dimming
- CCT: 4000K
- No UV/IR light